

VERMEIREN

Carpo 3, Carpo 4

USER MANUAL



Contents

Contents	1
Preface	2
1 Your product	3
1.1 Description	3
1.2 Accessories.....	4
2 Before use	5
2.1 Intended use	5
2.2 General safety instructions.....	5
2.3 Symbols on the scooter.....	6
2.4 Transport.....	6
2.5 First use and storage	7
3 Using your scooter	8
3.1 First ride	8
3.2 Operating your scooter.....	8
3.3 Transfer in and out of the scooter	12
3.4 Brake and free-wheel lever	12
3.5 Comfort adjustments	13
3.6 Automatic power shutdown	15
3.7 Charging the batteries.....	15
3.8 Thermal fuses	17
3.9 Anti-tipping	17
4 Maintenance	18
4.1 Cleaning.....	18
4.2 Expected lifespan.....	18
4.3 Reuse.....	19
4.4 End of use.....	19
4.5 Warranty.....	19
5 Troubleshooting	20
6 Technical specifications	22

Preface

Congratulations! You are now owner of a Vermeiren scooter!

This scooter is made by qualified and committed personnel. It is designed and produced according to high quality standards guarded by Vermeiren.

Thanks for your trust in the products of Vermeiren. To support you on the use of this scooter and its operating options, this manual is offered. Please read it carefully; it will help you to get familiar with the operation, capabilities and limitations of your scooter.

If you still have questions after reading this manual, do not hesitate to contact your specialist dealer. He/she will be glad to help you on this subject.

Important note

To ensure your safety and to prolong the lifetime of your product, please take good care of it and have it checked and/serviced on regular base.

This manual reflects the latest product developments. Vermeiren has the right to implement changes to this type of product without being imposed to any obligation to adapt or replace similar products previously delivered.

Pictures of the product are used to clarify the instructions in this manual. Details of the depicted product may deviate from your product.

Information available

On our website <http://www.vermeiren.com/> you will always find the most recent version of the information in this manual. Please consult this website regularly for possible updates.

Visually impaired people can download the electronic version of this manual and have it read out by means of a text-to-speech software application.



This user manual
For user and specialist dealer



User manual of battery charger
For user and specialist dealer



Service manual for scooters
For specialist dealer



EC declaration of conformity

1 Your product

1.1 Description

Carpo 3, Carpo 3D



1. Headrest
2. Backrest
3. Armrest / Armpad
4. Seat
5. Rear wheel
6. Footplate
7. Front wheel
8. Front light
9. Indicator lights
10. Rearview mirror
11. Handgrips
12. Basket
13. Freewheel lever

Carpo 4, Carpo 4D



14. Rear lights
15. Antitipping
16. Identification plate



1.2 Accessories

The following accessories are available for the scooters Carpo 3, Carpo 4, Carpo 3D, Carpo 4D:

- Wind screen
- Top case
- Crutch holder
- Rollator holder
- Elevated footplate
- Manual brakes

2 Before use

2.1 Intended use

In this paragraph a brief description of the intended use of your scooter is given. Additionally, relevant warnings are added to the instructions in the other paragraphs. In this way we would like to make you aware of the possible misuse that may appear.

- This scooter is classified as a class C product and is suitable for outdoor use.
- This scooter is designed and produced solely to transport one (1) person with a maximum weight of 150kg. It is not designed to transport goods or objects, or for any other use than the transport previously described.
- You should NOT use this scooter if you suffer from physical or mental impairments that may put you, or other people, in danger when driving the scooter, such as; visual impairment, mental disorder, hemiplegics or paraplegics. For this reason, consult your doctor first and make sure that your specialist dealer is informed about his advice.
- If applicable, only use accessories and spare parts approved by Vermeiren.
- Please read all technical details and limits of your scooter in chapter 6.
- The warranty on this product is based on normal use and maintenance as described in this manual. Damage to your product caused by improper use or lack of maintenance will cause the warranty to lapse.

2.2 General safety instructions

 CAUTION Risk of injuries and/or damage







Please read and follow the instructions in this manual. Otherwise you may get injured or your scooter may get damaged.

Keep the following general warnings in mind during use:

- Do not use your scooter if you are under the influence of alcohol, medicines or other substances that may influence your driving abilities.
- Be aware that some parts of your scooter may get very hot or cold due to ambient temperature, solar radiation, heating devices or due to the motor drive during the ride. Be careful when touching. Wear protective clothing if the weather is cold. After a ride, wait until the scooter/motor has cooled down.
- Before switching the scooter on, be aware of the environment/situation in which you are located. Adjust your speed to this before driving off. We advise you to use the slowest speed setting to drive indoors. For outdoor driving you can adjust the speed to a suitable speed at which you feel comfortable and safe.
- ALWAYS keep in mind that your scooter may stop suddenly due to a discharged battery or a protection that prevents your scooter from further damage. Also check the causes mentioned in chapter 6.
- Your scooter has been tested for electromagnetic compatibility and complies with the standard. Nevertheless, sources of electromagnetic fields, such as the fields of mobile phones, power generators or high-power energy sources, may influence the driving performance of your scooter. On the other hand, the electronics of your scooter may affect other electronic appliances as well, such as alarm systems of shops and automatic doors. We therefore advise you to check your scooter regularly for damage and wear, since these may enlarge the interference (see also chapter 4).
- Only drive on flat surfaces where all four wheels touch the ground and where there is sufficient contact to operate the scooter safely.
- Make sure that your hands, clothes, belts, buckles or jewellery don't get caught by wheels or other moving parts during use.

2.3 Symbols on the scooter

The symbols in following list are applicable for your scooter. Missing symbols can be found in the relevant ISO standard (ISO 7000, ISO 7001 and IEC 417).

	Maximum weight of the user
	Outdoor use
	Indoor use (battery charger only)
	Maximum safe slope in °.
	Maximum speed
	Type designation
	Risk of entrapment

2.4 Transport

2.4.1 Moving the scooter

The best way to carry the scooter is to make use of the neutral mode. Place the scooter in neutral and roll the scooter to the desired place.

If this is not possible, you can carry the scooter according to the following steps:

1. Switch the scooter off.
2. Remove loose parts (seat and batteries).
3. Store loose parts in a safe place.
4. Carry the frame + steering unit with 2 or 3 persons to the desired place. Hold the frame to the chassis or fixed parts of the frame, not the bumpers or the plastic parts.

2.4.2 Transport in the car

 **DANGER** Risk of injury - The scooter is not suited for use as a seat in a motor vehicle.

 **WARNING** Risk of injury

- Remove all loose parts prior to transportation.
- No people or objects should be under the scooter, on the footplate or seat during transportation.
- Make sure that the scooter is attached properly to avoid injury of the passengers during collision or sudden braking.
- Do not place fingers between the components of the scooter.

The best way to transport your scooter in the car is to drive the scooter in the car using ramps. When you are not experienced to drive the scooter using ramps, you can also put the scooter in neutral mode and push the scooter in the car using ramps.

When the scooter does not fit in the car, it is also possible to transport the scooter according to the following steps:

1. Remove all loose parts prior to transport (seat, etc.).
2. Store loose parts safely.
3. If possible, remove the batteries / battery boxes to save weight.
4. Fold the steering unit down with the angle adjustment.
5. Place the scooter in the car with 2 or 3 persons.
6. Attach the frame of the scooter securely to the vehicle.

2.5 First use and storage

CAUTION

Risk of battery damage

- Never completely discharge the battery.
- Do not interrupt the charging cycle; only disconnect the battery charger when the battery is fully charged.
- Make sure that your scooter is stored dry and indoors to prevent mould from growing and the upholstery from being damaged. If necessary, use a protective cover.
- Check the technical details for storage, see chapter 6.

Ensure that the battery has been fully charged before using your scooter, ask your dealer if this has already been done or not. To charge, follow the charging instructions in §3.7.



3 Using your scooter



WARNING

Risk of injuries

- First read previous chapters and inform yourself about the intended use. Do NOT use your scooter unless you have read and fully understood all instructions.
- In case of doubts or questions, do not hesitate to contact your local specialist dealer, your care provider or technical adviser to help you with this.

3.1 First ride



CAUTION

Risk of injuries and damage

- Make sure that your scooter is switched OFF when getting on and off.
 - Always unplug the battery charger from the scooter before starting to drive.
- i** Make sure you are familiar with the operation of your scooter before using it on crowded and possibly dangerous places. First exercise at a spacious, open area with little bystanders and ask someone to accompany you.

1. Make sure that:
 - the scooter is on a flat surface with all wheels touching the ground;
 - the battery is fully charged , see § 3.7;
 - the motor is coupled, see § 3.4;
 - the tyres have the correct tyre pressure, see § 6;
 - you have the correct sitting position;
 - all adjustments have been fixed securely.
2. Switch your scooter on, see § 3.2.
3. Set the speed to lowest speed setting, see § 3.2.
4. Put both hands on the handgrips of the tiller.
5. Slightly pull the right operating lever to drive to the front. Use the left operating lever to drive backwards. Release the lever to stop. Repeat this a few times.
6. If you feel confident enough, repeat this at a higher speed.
7. Now try to turn, in forward and backward direction. Repeat this a few times.
8. Make sure your scooter stands stable when ending the ride.
9. Switch off the scooter and remove the key to protect against theft.

3.2 Operating your scooter



WARNING

Risk of injuries or damage

- Do NOT drive on slopes, obstacles, steps or kerbs larger than the size described in the technical specifications in chapter 6.
- Take the local road traffic law into consideration; it may differ per country.
- Do not adjust the speed while you are driving.
- Take the weather conditions into consideration. Avoid driving by moist weather, extreme heat, snow, black ice, freezing temperatures; see technical specifications in chapter 6.
- To prevent tipping over, try to drive with a large turning radius at corners and curves. Do not cut corners and don't drive with sharp bends. Try to drive straight in small passages to prevent getting entrapped.
- Do not lean too far to the left/right/front/back of the scooter to prevent tipping over. Please pay specially attention when you are negotiating slopes and obstacles.
- Be aware of other road users to whom your scooter may be an obstacle. Pay special attention when turning, reversing or driving backward. If you are not acquainted with driving backwards, first practice in an open area. Indicate the direction you intent to go before cornering.

- When driving indoors, only use the lowest speed setting.
- Do not turn your scooter "OFF" while driving as this will lead to an emergency stop and possible risk of accident and injury.
- Keep the braking distance in mind, see also the technical specification in chapter 6. Be aware that the braking distance depends on speed, surface, weather conditions, slope and weight of the user.
- Pay attention if the road has holes or gaps that may cause entrapment of the wheels.

3.2.1 Operator control

- Switch the scooter ON by turning the key.
- The battery level indicator (1) will light up and show the current level of your batteries.
- Press the speed control (2, 3, 4) to select the desired driving speed.
 - Press button (4) to choose between the high/low speed setting.
 - Press button (2) to lower the speed within the chosen setting.
 - Press button (3) to raise the speed control.
- To sound the horn, press the horn button (5).
- To switch on the front and back lights, press the light button (7).
- To switch on the emergency flashers, press button (10).
- To switch on the indicator lights, press the desired button (9) (right indicator) or (8) (left indicator).

Carpo 3, Carpo 4



1. Battery level indicator
2. Speed control (slow)
3. Speed control (fast)
4. Speed switch
5. Horn
6. Lights (front and rear)
7. Indicator (left)
8. Indicator (right)
9. Emergency lights
10. Speed lever

Carpo 3D, Carpo 4D



1. Battery level indicator / LCD display
2. Speed control (slow)
3. Speed control (fast)
4. Speed switch
5. Horn
6. Set: change mode
7. Lights (front and rear)
8. Indicator (left)
9. Indicator (right)
10. Emergency lights
11. Speed lever

Carpo 3D, Carpo 4D : LCD display

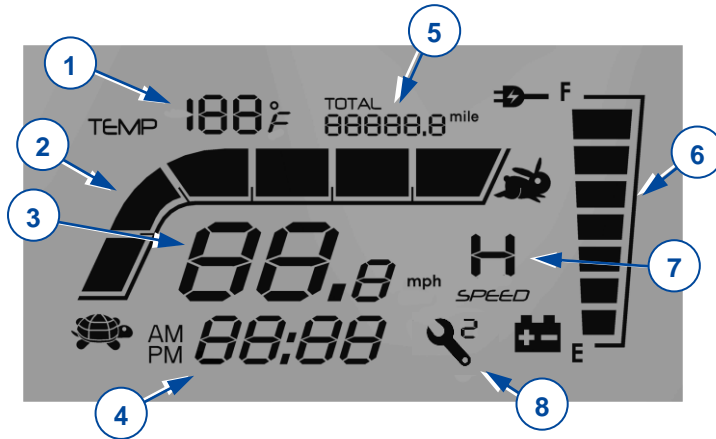

1. Temperature display
2. Speed bar
3. Speed display
4. Time display
5. Mileage or distance display
6. Battery indicator
7. High / slow speed mode display
8. Controller fault code

The time setting is linked to the battery system. Once you change to or connect new batteries, you must reset the time setting.

The system has a mileage memory for driving distance. You do not have to reset the mileage display after changing the batteries.

Carpo 3D, Carpo 4D : setting

Press **SET** to change mode,   to modify time and display.

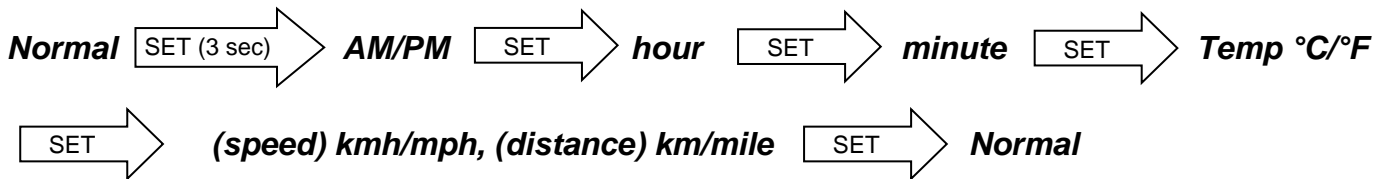

Vermeiren is responsible for the changes in the software. Contact your dealer or Vermeiren for questions or updates.

3.2.2 Operating the brakes (if applicable)

To apply the electromagnetic brakes:

1. Let go of the speed lever. The electromagnetic brake in the motor will be activated, the scooter will stop.

To apply the manual brakes (optional) - emergency brake:

1. Pull the brake lever (1) towards the handgrip.
2. Release the brake lever.

To apply the manual brakes (optional) - parking brake:

1. Pull the brake lever (1) towards the handgrip and use the button to lock it.
2. Squeeze the brake lever again to release the button.

The manual brake tightness can be adjusted with the brake cable adjuster.

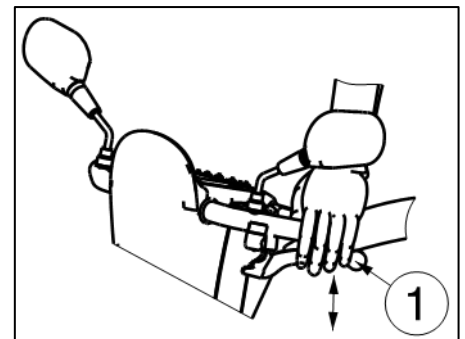

3.2.3 Driving the scooter

 WARNING Risk of injuries

- Do not use both sides of the speed lever simultaneously. This might leave you unable to control your scooter.

Move the speed lever in the required direction:

PULL ACTION BY THE RIGHT HAND = FORWARD MOVEMENT
PULL ACTION BY THE LEFT HAND = BACKWARD MOVEMENT

Pulling the lever more will increase the speed within the selected speed setting. Only use higher speed settings when you are confident that you can easily operate and control your scooter.

When you switch on the scooter, wait for 3 seconds before pulling the speed lever. Otherwise, the horn will sound as a warning and the scooter will not move. If this is the case, switch OFF the scooter and switch ON again.

3.2.4 Braking

To brake, let go of the speed lever. It will return to the neutral position and slow down your scooter to a gentle stop. Practice pulling away and braking to get accustomed to the scooter. You need to be able to estimate how your scooter will react when you drive or brake.

3.2.5 Driving around corners and in bends

 WARNING Risk of tipping injuries

- Reduce your speed before you enter a curve or corner.
- Always maintain an adequate distance from corners and obstacles.
- Do not drive your vehicle in an "S" pattern or make erratic turnings.

For corners and bends, use both hands to turn the handle bar in the direction you wish to take. It is very important that you ensure that there is enough space allowing you to go around bends and corners. Narrow passages must preferably be approached in a large curve so as to allow you to enter the narrowest part as straight from the front as possible. Bear in mind that your scooter's back part will in most cases be wider than the front part.

3.2.6 Backward movement

The speed of rearward movement is automatically reduced in comparison with forward driving. We also recommend that you use the slowest speed setting when you drive backward.

Do not forget that the steering direction with rearward driving is the opposite of when you go forward, and that your scooter will turn directly in the required direction.

The horn will beep while driving the scooter backwards.

3.2.7 Taking slopes

 WARNING Risk of injuries and/or damage

- Never put your scooter in free-wheel mode on a slope. The scooter may start moving, causing injuries to you or bystanders.
- Do not turn when driving down a slope, since the weight of the scooter may cause tipping over.
- Make sure all four wheels touch the ground while driving up or down.

Driving up

- Drive in a straight line and with higher speed on a slope, and lean slightly forward. When you drive in an angle or too slow, there is a risk of tipping over or falling.
- Never reverse on a slope.

Going downhill

- Drive in a straight line (forward or backward) and with lower speed on a slope. When you drive in an angle or too fast, there is a risk of tipping over or falling.
- Lean slightly backward during a forward descent; lean slightly forward during a backward descent.

3.2.8 Coping with obstacles

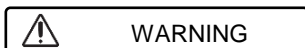

WARNING

Risk of injuries by unexpected movement

- Do not use your scooter on an escalator.
- Always approach a kerb from the front.
- Make sure that all wheels make contact to the ground when driving up or down.

It is possible to drive with your scooter over steps of 100 mm maximum. Take a 500 mm run-up to take these step.



3.3 Transfer in and out of the scooter

1. Park the scooter as close as possible to the place where you want to transfer.
2. Make sure that the scooter is switched off.
3. Turn the armpad upwards on the side where you want to transfer.
4. Swivel the seat if necessary (see §3.5.2).
5. Transfer to / from the seat of the scooter.



3.3.1 Correct position in the scooter

Some recommendations to comfortably use the scooter:

1. Position your lower back as close as possible to the backrest.
2. Make sure your upper legs are horizontal.

3.4 Brake and free-wheel lever



WARNING

Risk of injuries and/or damage

- Only operate the free-wheel lever when your scooter is turned OFF!
- An attendant should operate the free-wheel lever if you have impaired mobility. NEVER operate it from sitting position.

The scooter is fitted with a free-wheel device that is accessible and operable by the attendant, or the user when he/she is not sitting in the scooter. You should only put the scooter in neutral to transport the scooter or to move it out of a danger zone.

- Drive
 1. While the scooter is OFF, switch the freewheel lever to “drive”.
 2. Switch the scooter ON.
 3. Electronically controlled driving is now possible.
- Neutral
 1. Switch the scooter OFF.
 2. Switch the freewheel lever to “neutral”.
 3. The scooter can now be pushed without electronic drive.

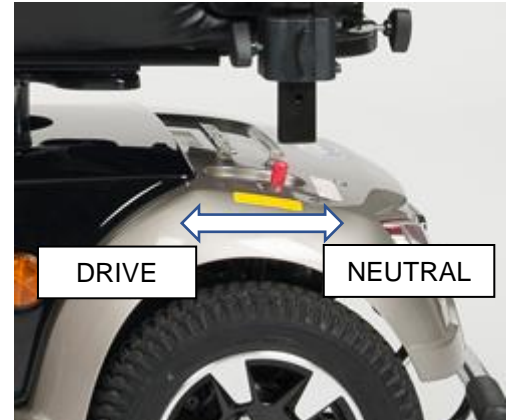

3.5 Comfort adjustments

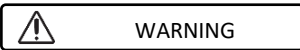

WARNING

Risk of injuries and/or damage

- Never perform adjustments while driving.
- The allowed adjustments can change the stability of your scooter (tilting back or sideways).

3.5.1 Adjusting the steering unit

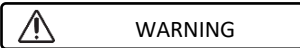

WARNING

Risk of injury

- Turn the scooter off before you adjust the angle of the steering unit.
- Do not lean with your whole body on the steering unit.

The steering unit can be adjusted to many different positions (stepless) to suit each driver.

1. Push the lever downwards.
2. Adjust the steering unit to the desired position.
3. Release the lever.



3.5.2 Adjusting the seat

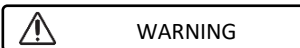

WARNING

Risk of injury

- Make sure that the seat is locked securely.

Removing the seat

1. Pull the seat lever (1) upwards.
2. Turn the seat a little bit and lift the seat out the adjustment bar.
3. Release the seat lever.



Placing and locking the seat into place

1. Pull the seat lever (1) upwards.
2. Place the seat on the adjustment bar and, at the same time, keep the seat lever pressed in.
3. Release the seat lever.
4. Make sure that the seat is firmly secured.

Swivelling the seat

1. Pull the seat lever (1) upwards.
2. Turn the seat in the desired direction.
3. Release the seat lever. The seat will always stop after 90°.
4. Make sure that the seat is firmly secured.

Depth adjustment



1. Pull the seat depth adjustment lever (2) upwards.
2. Move the seat forward or backward over the seat depth rails.
3. To lock the seat in place, let go of the lever once the seat has reached the desired position.
4. Swivel the seat a little until it locks in position.
5. Make sure that the seat is locked securely.

3.5.3 Adjusting the backrest

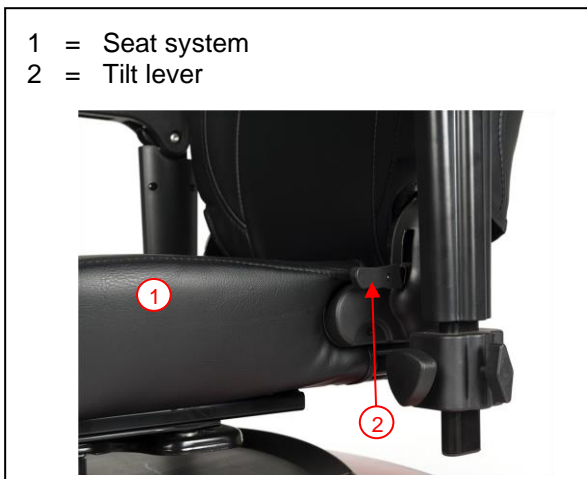

A tilt lever (2) has been added to the side of the backrest (transition to seat upholstery). Pull this lever upwards to release the backrest and fold the backrest forward (-75°), or adjust the angle of the backrest (0°-22°).

3.5.4 Adjusting the headrest:

1. Gently press the locking pin (1) toward the headrest.
2. Move the headrest to the desired height.
3. Let go of the locking pin (1).
4. The headrest audibly locks into place.

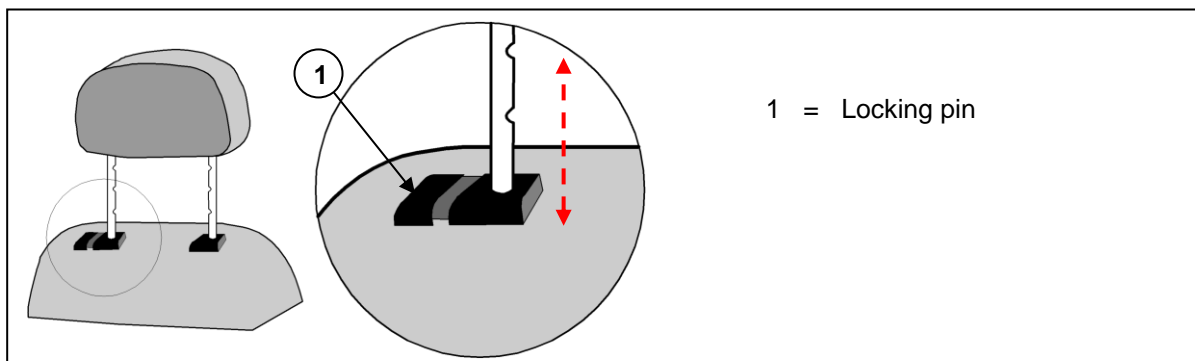

3.5.5 Adjusting the armrests



CAUTION

Risk of tipping over

- Make sure that the armrests are positioned symmetrically from the seat.
- Always mount the inner tube on a safe distance of 50 mm in the outer tube.

The armrest can be adjusted in height and depth.

Adjusting armrest height



CAUTION

Risk of injury - Do not put your fingers, buckles, clothes, jewelry between the swing away system of the armpad.



1. Fold the armpad backwards.
2. Loosen the star knob.
3. Grasp the armpad.
4. Move the armpad upwards or downwards until the desired height (range: 30 mm stepless).
5. Retighten the star knob.
6. Make sure that the armrest is well secured.

Adjusting armrest width



1. Loosen the star knob on the back of the scooter.
2. Grasp the inner square tube.
3. Move the tube to adjust the armrest to the desired depth (range: 120 mm each side stepless).
4. Retighten the star knob.
5. Make sure that the armrest is well secured.

3.6 Automatic power shutdown

In order to avoid accidental battery rundown, your scooter is equipped with an automatic power shutdown facility. If the scooter is switched on and remains undisturbed for a period of ten minutes, it will automatically turn off. Should this occur, simply switch your scooter off and back on and it will be ready to use again.

3.7 Charging the batteries



WARNING

Risk of injuries and damage due to fire

- Only use the battery charger delivered with the scooter. The use of any other charger may be dangerous (fire hazard).
- The battery charger is only intended to charge the batteries delivered with the scooter, not to charge any other batteries.
- Do not adapt any of the delivered parts, like cables, plugs or battery charger. Never open or change the battery or the connection points.
- Protect the battery and battery charger against flames, high and low temperatures (see chapter 6), moisture, sunshine, severe shocks (for example dropping). Do NOT use the battery if this has been the case.
- Charge the battery with the battery charger, indoors, in a well-ventilated area, out of children's reach.
- First read the user instruction of the applied battery charger before charging the scooter's battery. For more information, contact your specialist dealer or consult our website <http://www.vermeiren.com/>

CAUTION

Risk of damage

- Battery self-discharge and the quiescent current of the connected users will drain the battery charge slowly. The battery may be irreversibly damaged if the battery is fully discharged. Therefore, make sure that the battery is charged on time:
 - With intensive use (long distances, daily use): Immediately recharge after use.
 - With average use (short distances, daily or a few times a week): Charge when battery indicator shows 50% discharge.
 - With little use or storage: Charge once a week.
 - Read the storage and maintenance instructions in chapter 4 and technical details in chapter 6.
 - Only disconnect the battery charger when the battery is fully charged, see the following symbols on the charger.
 - Do not charge batteries below 0°C. Move the battery to a warmer place and start charging.
 - Keep the connection point for the battery charger free of dust and other contamination.
 - In case of any problems whereby the battery cannot be charged according to following instructions, please contact your specialist dealer.
 - For instructions on how to change the batteries, see the installation manual.
- i** • It is recommended to unplug the battery charger from the mains when not in use. This is to prevent unnecessary energy consumption.

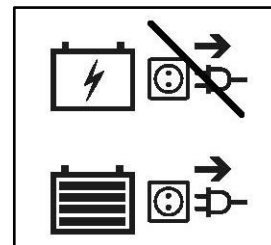

The light emitting diode (LEDs) in the steering unit indicates the remaining capacity of your batteries. If the battery charger is turned on and no LED's are lit, check the fuse. If the red LED does not illuminate, the charger is defective. Consult your specialist dealer.

1. Switch the scooter OFF and remove the key.
2. FIRST connect the battery charger to a 230V AC power socket.
3. If applicable, open the cover of the charging point on the scooter (1).
4. Connect the charger.
5. Refer to the battery charger manual for the explication of the indicators on the charger.
6. When the battery is fully loaded, disconnect the scooter from the charger.
7. Switch the scooter ON and check if all lights of the battery status indicator are ON.
8. Remove the charger from the socket, let it cool down and store it in a dry location.



- i** When the operating console displays the warning code “Drive inhibit” after charging, make sure that the battery charger is disconnected. This safety measure prevents driving with the charger still connected to the supply grid.

3.8 Thermal fuses



To protect the motor against overload, your scooter has a thermal safety mechanism on the rear. The thermal fuse will automatically cut off the motor to prevent overheating and thus rapid wear and tear or breakdowns. You can access the thermal safety device through a gap in the back of the synthetic cover.

The thermal safety device can be activated if you go up or down slopes that exceed the maximum specified gradient. Nominal loads that exceed the permitted maximum could also cause the device to jump out. Likewise, if you keep on driving with the engine brake on, it could result in overload. The maximum values not to exceed are indicated in §6.

To be able to use the scooter again, remove the overload and wait until the motor has cooled down. Then gently press the thermal safety mechanism back in. Your scooter is now ready for use again.

3.9 Anti-tipping



An anti-tipping (1) is fixed to the frame of the scooter on the rear side. It is not possible to remove these. The anti-tipping is there for your safety. It prevents the scooter from tipping over backward when you drive over small obstacles that do NOT exceed the maximum height as specified in §6.



4 Maintenance

- i** Regular care ensures that your scooter is preserved in a perfectly functional condition. For the maintenance manual, refer to the Vermeiren website: www.vermeiren.com.



CAUTION

Risk of injuries and damage

Repairs and replacements may only be undertaken by trained persons and only genuine replacement parts of Vermeiren should be used.

- i** The last page of this manual contains a registration form for the specialist dealer to record each service.

The service frequency depends on the frequency and intensity of use. Contact your dealer to agree to a common timetable for inspection/maintenance/repair.

Before each use

Visually inspect the following points:

- Battery status: Charge the battery when necessary, see § 3.7.
- Condition of wheels/tyres: Correct pressure, profile, no damage.
- General condition.

Contact your specialist dealer for possible repairs or part replacements.

Monthly

If your scooter is stored for a longer period, you still need to charge the batteries monthly. For more information, see § 3.7.

Yearly or more often

Have your scooter inspected and serviced by your specialist dealer at least once a year, or more often. The minimum maintenance frequency depends on the frequency of use and should therefore be commonly agreed upon with your specialist dealer.

If stored

Make sure that your scooter is stored in a dry environment to prevent mould from growing or the upholstery from being damaged. Disconnect the battery to prevent it from being damaged.

4.1 Cleaning

CAUTION

Risk of damage by moisture

- Keep the operating console clean and protect it from water and rain.
- Never use a hose or high-pressure cleaner to clean the scooter.

Wipe all rigid parts of the scooter with a damp cloth (not drenched). If necessary, use a mild soap, suitable for varnishes and synthetics.

The upholstery can be cleaned with lukewarm water and a mild soap. Do not use abrasive cleaning agents to clean.

Keep the ventilation openings of the battery charger clean and free of accumulated dust. Blow away the dust and clean the battery charger enclosure with a slightly moistened cloth, if required.

4.2 Expected lifespan

The average lifespan of your scooter is 5 years. Depending on the frequency of use, driving circumstances and maintenance, the lifespan of your scooter will increase or decrease.

4.3 Reuse

Before each reuse, have the scooter disinfected, inspected and serviced according to the instructions in the maintenance manual.

4.4 End of use

At end of life, you need to dispose of your scooter according to the local environmental legislation. The best way to do so, is to disassemble the scooter to facilitate the transport of recyclable parts. Usually, batteries are collected separately.

4.5 Warranty

The warranty on this product is subject to the general terms and conditions of each country, as you can consult on our company website.

5 Troubleshooting

Even if you use your scooter properly, a technical problem may occur despite this. In this case, contact your local specialist dealer.



WARNING

Risk of injuries and damage to the scooter

- NEVER attempt to repair your scooter yourself.
- For problems in the operating console you need to contact your specialist dealer. He/She will decide if the console needs to be reprogrammed.

The following symptoms may indicate a serious problem. Therefore always contact your specialist dealer if you spot any of the following deviations:

- Strange sound;
- Frayed/damaged wiring harnesses;
- Cracked or broken connectors;
- Uneven tread wear at one of the tyres;
- Jerky movements;
- Scooter deflects to one side;
- Damaged or broken wheel assemblies;
- Scooter does not switch on;
- Scooter is powered, but does not move to the front or back.

In case of a possible problem, a system code is displayed on the battery level indicator (for Carpo 3, Carpo 4 by determining the blinking LED's as in Table 1) or on the LCD display (for Carpo 3D, Carpo 4D), see §3.2.1.

Table 2 summarises the possible system codes. Some problems can be solved by yourself. For all problems marked in grey, consult your specialist dealer.

Table 1: Battery level indicator illuminated LED's

Code \ LED	1	2	3	4	5	6	7
1	#	#					
2	#						
3	#	#	#	#	#	#	#
4		#					
5			#				
6				#			
7					#		
8						#	
9							#

Table 2: Troubleshooting

Code	Possible problem	Meaning
1	Low battery	Recharge the battery immediately.
2	Low battery	Recharge the battery. Check the battery and all associated connections and wiring. If the problem is not solved, contact your specialist dealer.
3	High battery	If traveling down a slope, stop / reduce your speed. Take less steep slopes.
4	Current limit time-out OR Controller too hot	Turn off the scooter, leave for a few minutes and turn back on. Check the motor and associated connections and wiring. If the problem is not solved, contact your specialist dealer.
5	Parking brake	Check the parking brake / free-wheel lever and associated connections and wiring. If the problem is not solved, contact your specialist dealer.
6	Drive inhibit	Disconnect the battery charger. OR Release the speed lever before switching on your scooter.
7	Speed pot	Check the throttle and speed pot, as well as all associated connections and wiring. Contact your specialist dealer.
8	Motor voltage	Check the motor and associated connections and wiring. Contact your specialist dealer.
9	Other	Check all connections and wiring. Contact your specialist dealer.

6 Technical specifications

The technical specifications below are valid for the scooter in standard settings and optimum environmental conditions. If other accessories are used, the tabulated values will change. Changes in outdoor temperatures, humidity, uphill, downhill, soils and battery levels can reduce output.

Brand	Vermeiren
Type	Rear wheel drive scooters, Class C
Maximum occupant mass	150 kg
Model	Carpo 3, Carpo 4, Carpo 3D, Carpo 4D

Description	Carpo 3, Carpo 3D	Carpo 4, Carpo 4D
Length	1400 mm	1450 mm
Width	660 mm	
Height	1200 mm	1350 mm
Folded / dismantled length	Not foldable	
Folded / dismantled width	Not foldable	
Folded / dismantled height	550 mm (seat removed; steering unit folded)	700 mm (seat removed; steering unit folded)
Total mass	127 kg	131 kg
Mass of heaviest part (that can be dismantled or removed)	107 kg (without seat) or 83,65 kg (without seat and batteries)	111 kg (without seat) or 87,65 kg (without seat and batteries)
Masses of parts that can be dismantled or removed	Seat: 19,85 kg; Batteries: 23,50 kg	
Rated slope	9°	
Ground clearance	50 mm (anti-tipping)	
Obstacle climbing	100 mm	
Max. speed	15 km/h	
Continuous driving distance range*	45 km	
Min. battery	75 Ah (C20), 12V DC, non-spillable AGM battery, maintenance-free	
Seat plane angle	2°	
Effective seat depth	490 mm	
Seat surface height at front edge (measured from ground)	655 – 730 mm	
Seat surface height at front edge (measured from footplate)	455 - 530 mm	
Height footplate	200 mm	
Backrest angle	-75° / 22°	
Backrest height	530 mm / 720 mm with headrest	
Distance between armpad and seat	240 mm	270 mm
Front location of armrest structure	330 mm	
Motor	Nom. 750 Watt, electromagnetic brakes	
Battery charger	8 Amp (external)	
Protection class	IPX4	
Battery charger protection class	IPx1	
Battery charger insulation class	II	



Technical specifications

Brand	Vermeiren
Type	Rear wheel drive scooters, Class C
Maximum occupant mass	150 kg
Model	Carpo 3, Carpo 4, Carpo 3D, Carpo 4D

Description	Carpo 3, Carpo 3D	Carpo 4, Carpo 4D
Minimum turning diameter	3030 mm	2960 mm
Reversing width	1900 mm	
Diameter rear wheels (number)	14" air (2)	
Tyre pressure, rear (driving) wheels	Max. 3,4 bar	
Diameter steering wheels (number)	13" air (1)	14" air (2)
Tyre pressure, steering wheels	Max. 3,4 bar	
Storage and use temperature	-15 °C to +40 °C	
Storage and use humidity	30% - 70%	

We reserve the right to introduce technical changes. Measurement tolerance ± 15 mm / 1,5 kg / 1,5°.

*** The theoretical driving distance will be reduced if the scooter is used frequently on slopes, rough ground or to climb curbs.**



Service registration form

This product (name):

was inspected (I), serviced (S), repaired (R) or disinfected (D):

By (stamp): Kind of work: I / S / R / D Date:	By (stamp): Kind of work: I / S / R / D Date:	By (stamp): Kind of work: I / S / R / D Date:
By (stamp): Kind of work: I / S / R / D Date:	By (stamp): Kind of work: I / S / R / D Date:	By (stamp): Kind of work: I / S / R / D Date:
By (stamp): Kind of work: I / S / R / D Date:	By (stamp): Kind of work: I / S / R / D Date:	By (stamp): Kind of work: I / S / R / D Date:
By (stamp): Kind of work: I / S / R / D Date:	By (stamp): Kind of work: I / S / R / D Date:	By (stamp): Kind of work: I / S / R / D Date:
By (stamp): Kind of work: I / S / R / D Date:	By (stamp): Kind of work: I / S / R / D Date:	By (stamp): Kind of work: I / S / R / D Date:



Vermeiren GROUP
Vermeirenplein 1 / 15
2920 Kalmthout
BE

website: www.vermeiren.com

Instructions for specialist dealer

This instruction manual is part and parcel of the product and must accompany every product sold.

Version: G, 2021-05

Basic UDI: 5415174 122124Carpo 3 GP
5415174 122124Carpo 4 GR

All rights reserved, including translation.

No part of this manual may be reproduced in any form what so ever (print, photocopy, microfilm or any other process) without written permission of the publisher, or processed, duplicated or distributed by using electronic systems.

© Vermeiren Group 2021